



User's Handbook

Mindesk for Rhinoceros 6
v 3.0.0

Last update August 2019

Contents

01. Getting Started

- Minimum Equipment Requirements
- Supported VR/AR Devices
- System Info and options
- Installation
- First Boot
- Mirror Window

02. Learning Basics

- User Interface
- Controller Configurations
- Tool Palette
- Selection and Navigation

03. Design Tools

- Make
- Surface
- Review

04. Precision Options

- VR SNAP Options
- Magnetic guidelines
- Smart Tracking
- Lock Constraint
- 3D Grid

05. Grasshopper VR

- Immersive interface
- MDSK Geometry
- MDSK Text

Getting Started

Getting Started

Minimum Equipment Requirements

Mindesk is the first VR/AR interface for desktop CAD software. Before diving into the matrix, you should have your computer ready for VR/AR. Please reference tech specs below,



Processor

Intel Core
i5-4590/AMD FX
8350 equivalent
or better

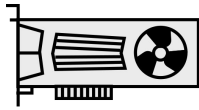

GPU

NVIDIA GeForce GTX
1060, AMD Radeon RX
480 equivalent or better

Note: See [Nvidia's list of VR ready graphic cards](#). (Please scroll down to the Support section, click on supported GPUs)

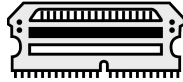

Memory

4 GB RAM or more

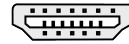

Video Output

HDMI 1.4,
DisplayPort 1.2 or
newer



USB Port

1x USB 2.0
or newer



Operating System

Windows 7 SP1,
Windows 8.1 or
later, Windows 10

Getting Started | Supported VR/AR Devices

To use Mindesk, you will then need a PC-based headset with two 6 degree-of-freedom controllers. Mindesk currently supports HTC Vive, Oculus Rift, and Windows Mixed Reality (WMR) to serve designing in VR. Choose your preferred VR device for Mindesk.



Getting Started | System Info and Options

Now, you have all hardware equipments ready to go. Let's set up the system before really jumping into Mindesk. Not matter what type of user (Vive/Rift/WMR) you are, SteamVR is required to be [installed](#) before hand. Note, if you are a WMR user, you need to install Mixed Reality Portal as well. To have better experiences with Mindesk, we recommend you to adjust SteamVR supersampling settings before entering VR.

1. Go to SteamVR, open the menu and select "Settings".

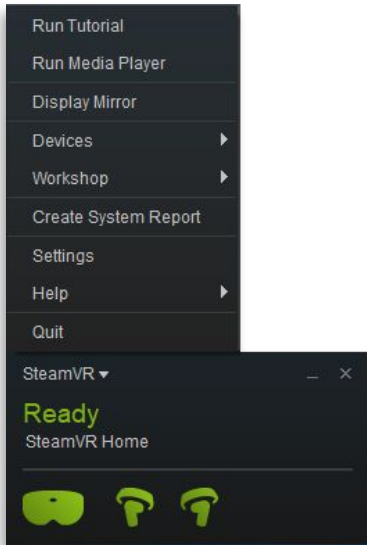

2. On "Settings", click "Application" tab, when Mindesk is activated, select "Viewer.exe" for Per-Application Settings. Then, slide right to adjust the resolution to 200%.

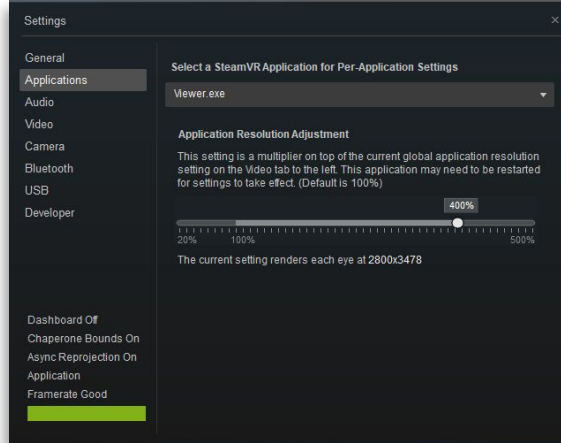

3. Click the "Developer" tab, follow the below picture to check/uncheck the options.

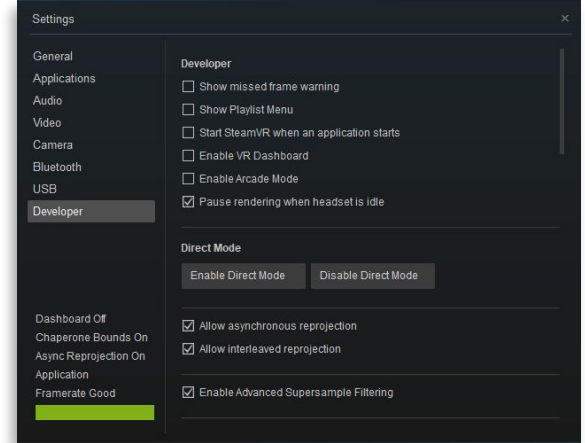

Getting Started | Installation

Downloading Mindesk

Go to mindeskvr.com/setup, sign up for a mindesk account.

Follow the steps to download the latest version of Mindesk. If you already registered, log in to download.

Installing Mindesk

To install Mindesk, just open the .rhi package and follow the instructions.

Mindesk Options

Email

The current user's email is displayed here.

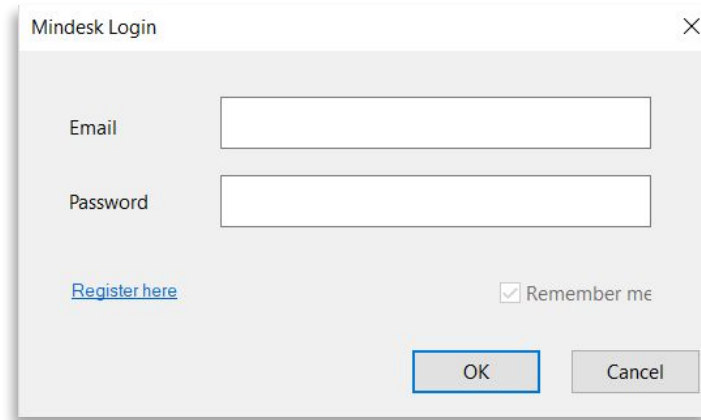
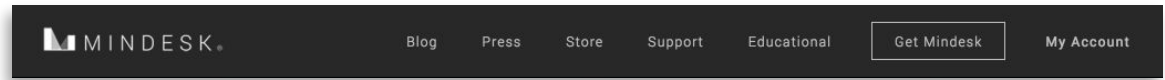

Getting Started | First Boot

Booting/stopping Mindesk

If this is your first boot, you need to log into Mindesk by entering your email address and password (the same used to register on www.mindeskvr.com).

Once installed, boot McNeel Rhinoceros and type “MindeskStartVR” on Rhino’s command line to boot Mindesk. You can check “Remember me” for your next session. Alternatively, you can select “Start VR” from the “Mindesk” sub-menu in Rhino toolbar.

You can safely stop Mindesk by just closing the VR Viewer window, or by typing “MindeskStopVR” on the Rhino command bar, or by clicking “Stop VR” from the “Mindesk” sub-menu in Rhino toolbar.

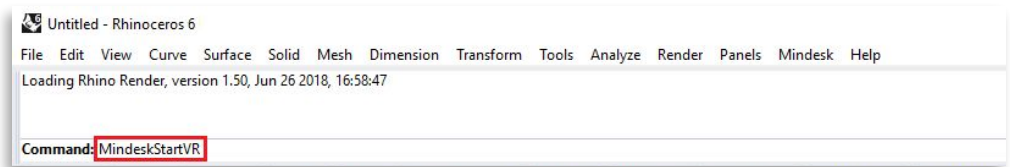
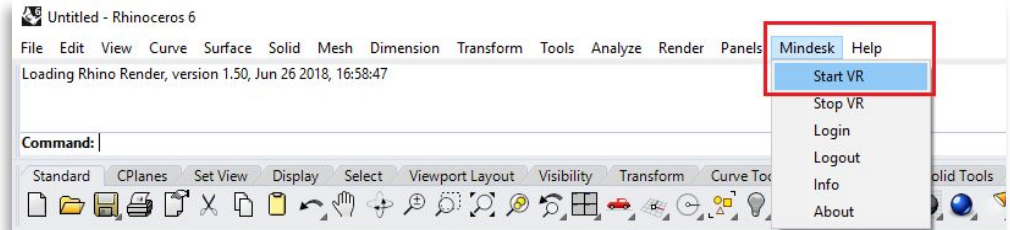
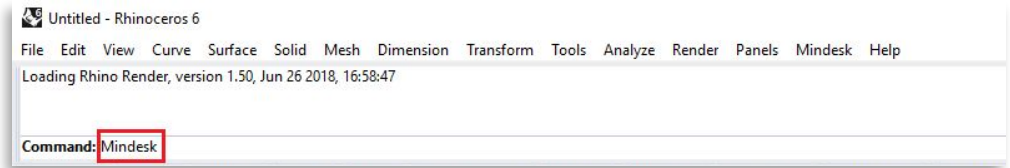

Mirror Window

For the desktop user, here are some quick commands on the keyboard to go.

M = toggle mirror camera, HMD point of view and Vive tracker (if connected) for mixed reality videos

I = invert controllers

F11 = fullscreen

You can record and share your sessions through an external screen recorder.

We recommend using [OBS Studio](#), a free software.



Learning the Basics

VR-CAD User Interface

Mindesk VR interface allows you to control McNeel Rhinoceros 6™ (“Rhino”) by using your VR controller instead of mouse and keyboard.

You can still use Rhino in the traditional way by just removing your headset. Once you start Mindesk, turn on your VR controllers and continue working immersed in the Rhino space.

Your controllers are replaced by two virtual controllers in the virtual world. The left one is marked with a red M, while the right one has a blue M engraved on it. This allows you to easily recognize controllers, since they're used for different functions.

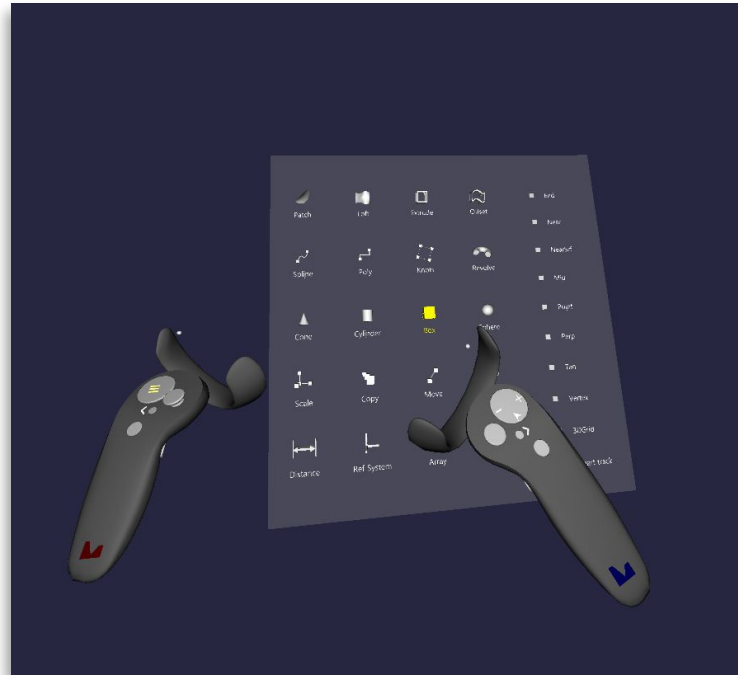

HTC Vive controllers configuration

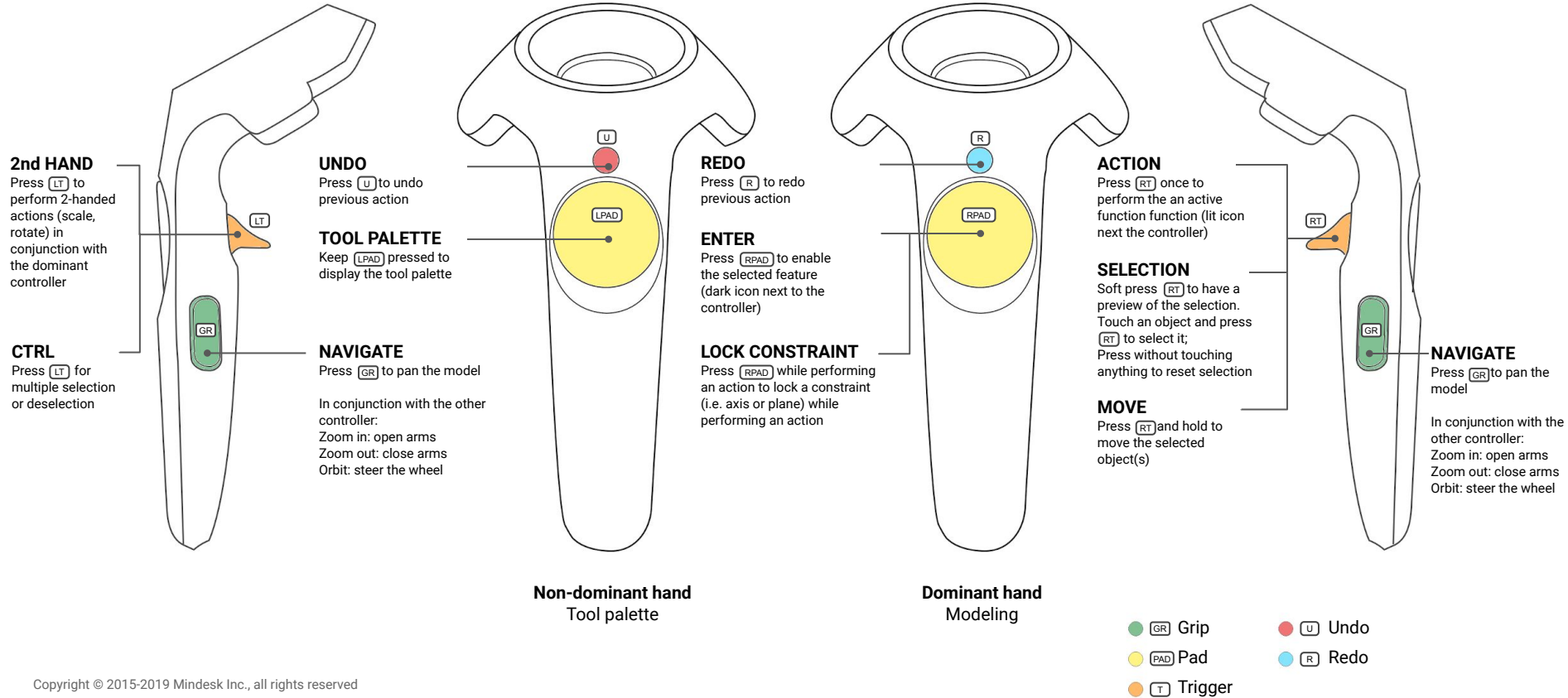

Oculus Rift controllers configuration

TOOL PALETTE

Keep **[LPAD]** pressed to display the tool palette

UNDO

Press **[U]** to undo previous action

NAVIGATE

Press **[GR]** to pan the model

In conjunction with the other controller:
Zoom in: open arms
Zoom out: close arms
Orbit: steer the wheel

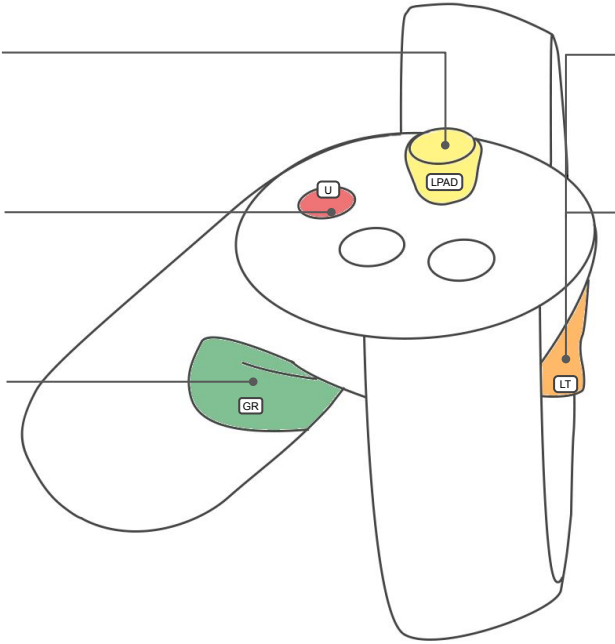

Non-dominant hand
Tool palette

2nd HAND

Press **[LT]** to perform 2-handed actions (scale, rotate) in conjunction with the dominant controller

CTRL

Press **[LT]** for multiple selection or deselection

ACTION

Press **[RT]** once to perform the an active function (lit icon next the controller)

SELECTION

Soft press **[RT]** to have a preview of the selection. Touch an object and press **[RT]** to select it; press without touching anything to reset selection

MOVE

Press **[RT]** and hold to move the selected object(s)

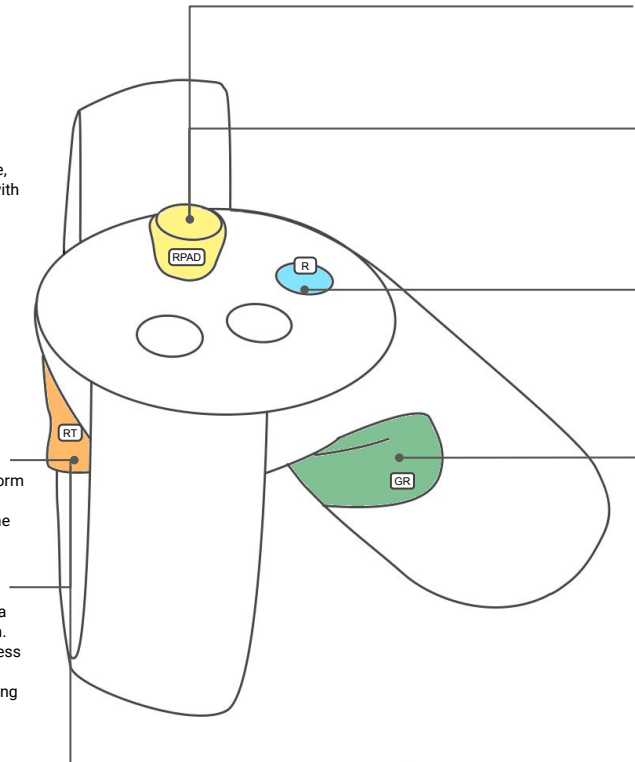

Dominant hand
Modeling

ENTER

Press **[RPAD]** to enable the selected feature (dark icon next to the controller)

LOCK CONSTRAINT

Press **[RPAD]** while performing an action to lock a constraint (i.e. axis or plane) while performing an action

REDO



Press **[R]** to redo previous action

NAVIGATE

Press **[GR]** to pan the model

In conjunction with the other controller:
Zoom in: open arms
Zoom out: close arms
Orbit: steer the wheel

-  **[GR]** Grip
-  **[PAD]** Pad
-  **[T]** Trigger

-  **[U]** Undo
-  **[R]** Redo

Windows Mixed Reality controllers configuration

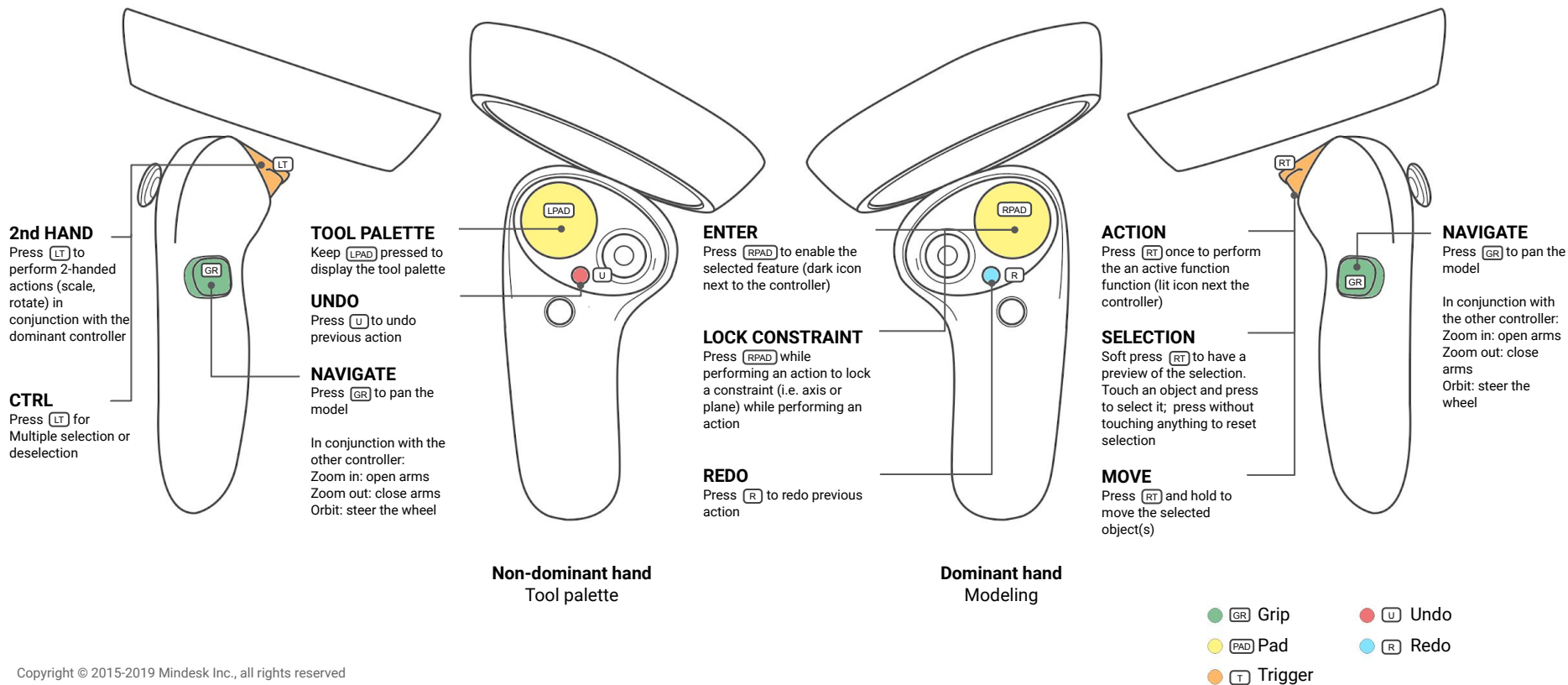

Make

The Make section of the tool palette contains all main design tools used in Mindesk. You can select design tool from the palette before start working on your project.

Press the Pad button on the left controller to open the tool palette. While the palette is open, hover the right controller to select the desired tool and press the right trigger button to activate it. Once successfully picked, the tool should appear on the side of each controller.

In the tool palette you can activate and deactivate VR SNAP tools as well.

The tool palette is divided into two areas: design tools are listed on the left as 3D icons, while VR SNAP functions are listed to the right as text.

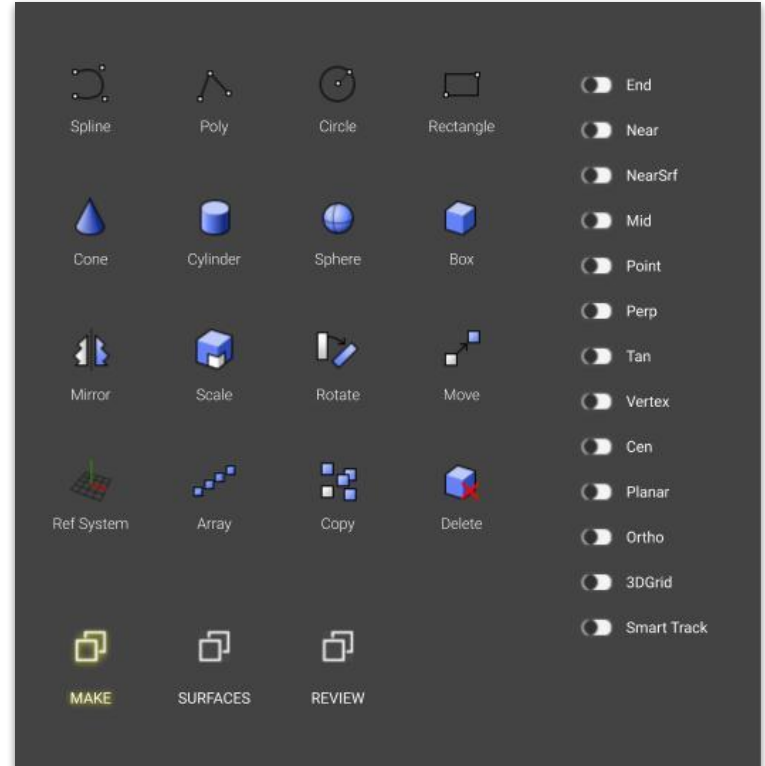

Surfaces

The Surfaces section contains the main surfacing tools used in Rhinoceros. With these features you can create surfaces starting from Rhino curves or edit existing ones.

To use a tool just follow the same procedure as for the features in the Make section.



Review

The Review section contains inspection and markup tools used in design reviews. You can select design tool from the palette before start working on your project.

To use a tool just follow the same procedure as for the features in the Make section.

The right area of this section hosts a list of the main view scale. Use the switches to lock the VR navigation on a particular view scale.



Object Selection

Selection:

Approach the right controller to the target object and press **[RT]** to select it. Within a certain distance, Mindesk would select the nearest object.

If your model has many objects, soft press **[RT]** for a selection preview.

Additive selection:

Keep **[LT]** pressed and select the objects with the right controller. The selected objects will stay so even if you stop pressing the left trigger.

Object Deselection

Subtractive selection:

Keep **[LT]** pressed and deselect the objects with **[RT]**. The rest of objects will stay selected.

Deselect all:

Point the right controller in an empty space and press **[RT]**.

Navigation

Pan:

press and hold either left or right **[GR]**

Orbit:

press both **[GR]** and "steer the wheel" (pretty much like Google Maps)

Zoom:

press both **[GR]** and "pinch to zoom" (pretty much like Google Maps)

Undo action:

press **[U]** on the left controller

Redo action:

press **[R]** on the right controller

Learning the Basics

Selection and Navigation

Simple selection

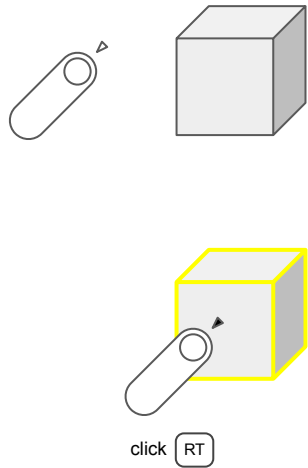

Multiple additive

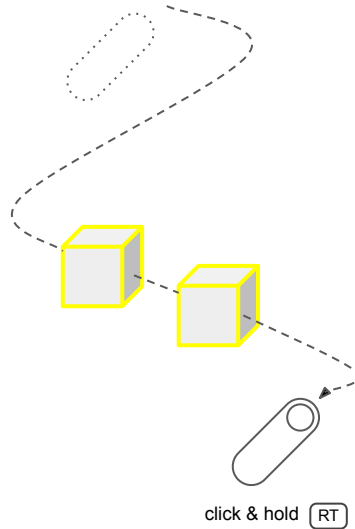

Multiple subtractive

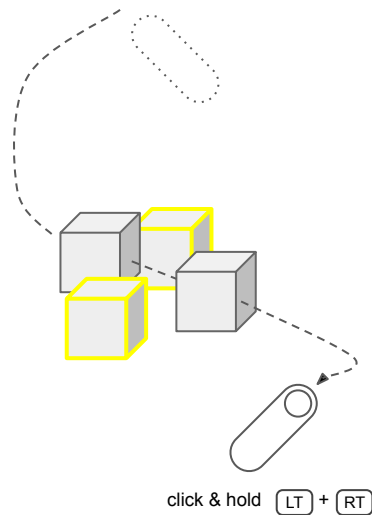

Copy

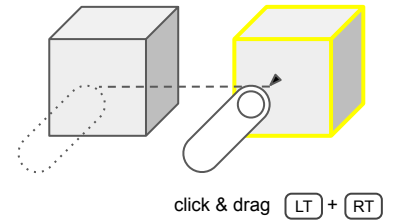

Design Tools

Design Tools

| Make



Spline



Poly

Click **RT** to start drawing a 3D spline / poly and add control points.

Click **RT** on the latest control point or **RPAD** anywhere to end drawing an open spline / poly.

Click **RT** on the first control point to close the spline / poly.



Circle



Rectangle

Click and drag **RT** to create a circle / rectangle. While dragging **RT** you can change the size, release **RT** to complete the action.

(or) Click **RT** to define the center / first point and click **RT** again to define the radius / second point. The plane of the curve is defined by the position of the second point with respect to the first point and is generally aligned with the Ref Sys.



Cone



Cylinder



Sphere



Box

Click and drag **RT** to create the bidimensional base shape. While dragging **RT** you can change the size, release **RT** to complete the base, click **RT** again to set the third dimension of the solid.

(or) Click **RT** to define the first dimension, click **RT** again to define the second dimension and a third time to define the third dimension of the solid.

The sphere needs two input points only: center and diameter.

The plane of the base is defined by the position of the second point with respect to the first point and is generally aligned with the Ref Sys.

Design Tools

Make



Mirror

Select the target objects, click **RT** to define an anchor point, click **RT** again to define a mirror vector. The target objects are mirrored with respect to the plane normal to the mirror vector.

(or) Click **RT** to define the anchor point, then click **RT** and drag to define the mirror vector.



Move



Copy

Select the target objects, click **RT** to set the origin and click **RT** to set the destination point. The target objects are moved / copied from the origin to the destination point.

(or) Press **RT** and drag to move the target objects.



Scale



Rotate

Select the target objects, click **RT** to define an anchor point, click **RT** to define a scale / rotation reference point, then click **RT** again to define the measure and complete the operation with respect to the anchor point.

(or) Click **RT** to define the anchor point, then click **RT** and drag to define the direction and magnitude of the transformation.

While scaling, transformation (1D, 2D, or 3D) and the scale factors are determined by the second and third point.

While rotating, the rotation plane and angle are determined by the second and third point

Design Tools

Make



Ref System

Press and drag **RT** to move the reference system. While moving the reference system, use **LT** to grab the handlers on the axis and rotate the reference system around its origin.

The rotation plane is defined by the handler grabbed and the direction in which the handler is moved.



Delete

Select the target objects and click **RT** to delete them.



Array

Select the target objects, click **RT** to define an anchor point, move the controller in the direction of the array and click **RT** to generate the first copy, then move the controller in the same direction and click **RT** again to define the number of instances.

(or) Press **RT** and drag to define the anchor point and generate the first copy, then move the controller in the same direction and click **RT** again to define the number of instances.

Design Tools

| Surfaces



Revolve

Select the profile curve, click **RT** to define an anchor point, click **RT** to define the revolve reference point, then click **RT** again to define the angle and complete the operation with respect to the anchor point.
(or) Click **RT** to define the anchor point, then click **RT** and drag to define the angle and plane of revolution.



Loft



Patch

Select the generating curve/s, click **RT** to generate a lofted / patched surface from the generating curve/s.



Extrude



Offset

Select the source objects, click **RT** to define an anchor point, click **RT** to define the extrude / offset distance.

(or) Press **RT** and drag to extrude / offset the source curve / surface.

In case of extrusion the second click defines the direction of extrusion.



Knots

Select the target objects, click **RT** to activate its control points. Click **RT** in an empty point to turn off the control points.

Once active, control points can be grabbed with **RT** and moved around to deformate the object. Control points can be also rotated and scaled.



Brush

Press and hold **RT** to draw a mark in the space.

The mark is stored on the Rhino CAD file as a polyline on the _Mindesk brush layer and can be used to leave notes or suggest edits. The user can treat the mark as a normal Rhino object along with other commands like copy, move, and delete. It is possible to snap on the mark.



Distance

Click and drag **RT** to measure the distance between the start and end points.

(or) Click **RT** to define the start point, click **RT** again to define the end point.

Temporary quotes for X,Y, and Z axis as well as for direct distance will appear. Click **RT** again to reset the measure.

Precision Options

Geometric Constraints

Located on the right side of the tool palette, VR SNAP options can be activated to make super precise models. Like in Rhino, each snap enables a different geometric constraint:

End	snap to the end points of the nearest curve or edge
Near	snap to the closest point on the nearest curve
NearSrf	snap to the closest point on the nearest surface
Mid	snap to the middle point on the nearest curve or edge
Point	snap to points and knots
Perp	snap to any point on the nearest curve perpendicular to current curve in progress
Tan	snap to any point on the nearest curve tangent to current curve in progress
Vertex	snap on the closest vertex of a mesh
3D Grid	snap to the closest point on a 3D Grid which size is determined by the user
Smart Track	toggle smart tracking

When a snap point is detected, the cursor turns yellow.

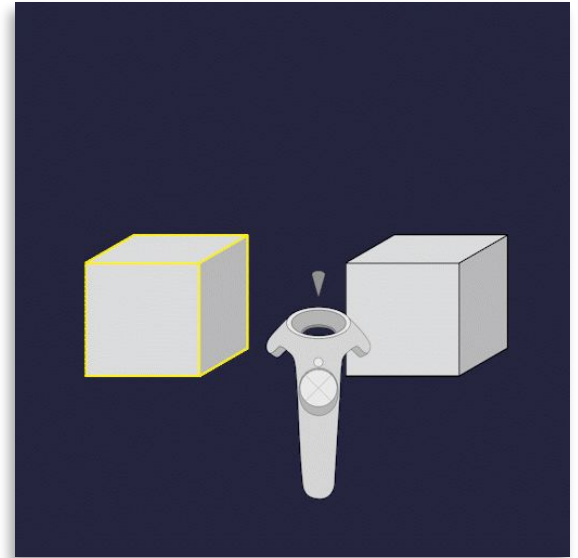

Magnetic Guidelines

While drawing a polyline, moving a solid, or copying an object, magnetic guidelines show up to help you aligning geometries along local X, Y, or Z axes. Also, magnetic guidelines helps aligning objects on XY, YZ, or ZX planes and the respective diagonal vectors.

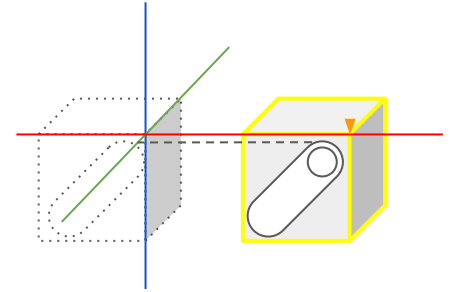

Smart Tracking

Smart tracking helps to align an object with distant Reference Points which you snapped to. To activate the smart tracking on a Reference Point, hover the pointer on it once, hover again to deactivate it. You can activate up to 8 smartrack Reference Points. Active Reference Points are displayed in gray.

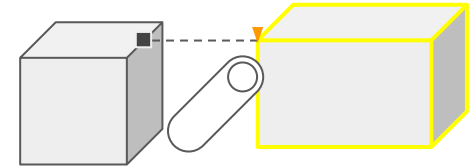

Lock Constraint

Lock Constraint help you constraint the move of an object onto an axis, a plane, or a surface. While the object is constrained you can snap on distant objects. This is particularly handy when it comes to aligning objects. In Rhino this operations is called "*snappy draggy*". To constraint an object click the Right Pad button while moving an object on a magnetic axis or plane or surface. The icon on the right pad turns red when the object is constrained.

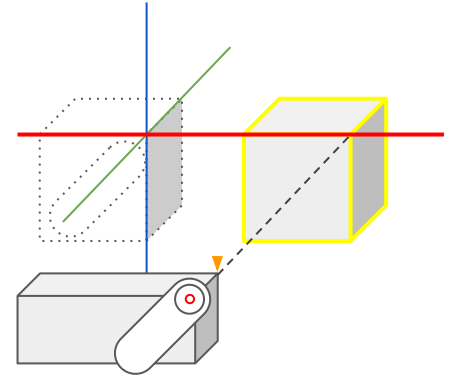

3D Grid

While drawing a polyline, moving a solid, or copying an object, if active, 3D Grid can help you inputting precise, modular measures. The grid size depends on the zoom level and will dynamically adapt to it. If you need a finer grain, just zoom in. Zoom out for a thicker grain.

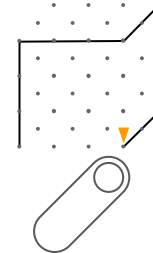

Grasshopper Component

Grasshopper VR | Immersive interface

While Mindesk and Grasshopper are running, it is possible to use the Grasshopper canvas from the last section in the Mindesk tool palette.

Note: it is important that the desktop Grasshopper window is on top to be properly displayed in VR

Interaction

Use the right controller to point and interact with the Grasshopper window in VR. While pointing the GH window, the controller will not interact with other objects in VR.

RT = Right mouse click (select, move and link GH components)

LT + RT = Left mouse click (open contextual menu)

RPAD = Canvas navigation (press to pan, slide up/down to zoom)

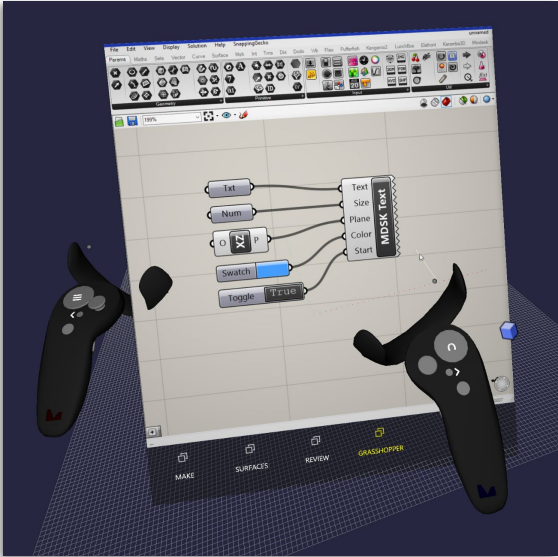

Geometry

Objects inputted in the Geometry connector are rendered in VR when Mindesk is running. The component can manage single items, lists and trees. The component accepts points, curves, surfaces, meshes and breps.

Color

The connector accepts Grasshopper Colors, including Alpha channels for transparency. In general, geometry and color trees should match. If geometries outnumber colors, "longest list" logic applies.

Start

This connector accepts a boolean toggle. While Mindesk is running, set toggle to "True" to link Grasshopper and VR. Set toggle to "False" to unlink Grasshopper from your Mindesk VR session.

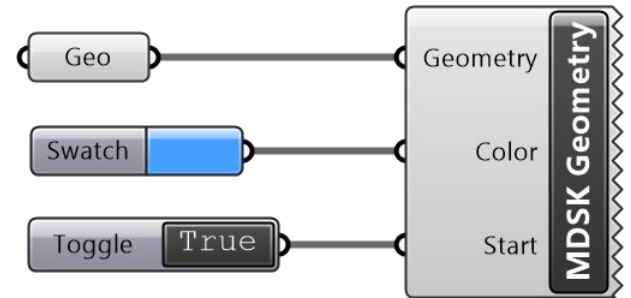

Grasshopper VR | MDSK Text

Text

Strings inputted in the Text connector are rendered in VR when Mindesk is running. The component can manage single items, lists and trees.

Size

The connector accepts numbers, lists of numbers, and trees. The inputted numbers affect the related text sizes.

Plane

The connector accepts planes, lists of planes, and trees. The inputted plane affect the related text orientation.

Color

The connector accepts Grasshopper Colors, including Alpha channels for transparencies. In general, geometry and color trees should match. If geometries outnumber colors, "longest list" logic applies.

Start

This connector accept a boolean toggle. While Mindesk is running, set toggle to "True" to link Grasshopper and VR. Set toggle to "False" to unlink Grasshopper from your Mindesk VR session.

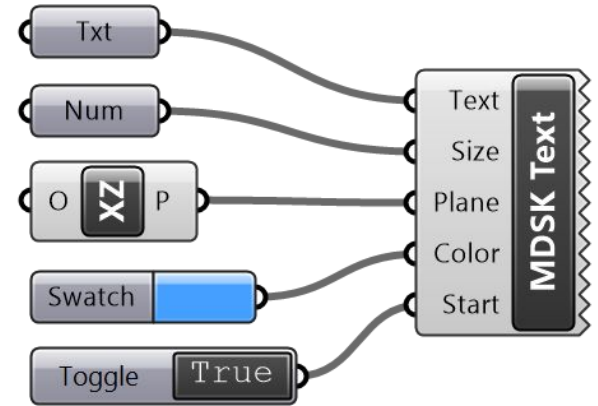

Made with  by Mindesk team

If you need to ask us anything, please post a question at <https://www.mindeskvr.com/support/>